



S SD9363-EHL-v2

Speed Dome Network Camera

1080p 60 fps • 20x Zoom • 150M IR • IP66 • IK10 •
NEMA 4X • -50°C ~ 55°C

The SD9363-EHL-v2 is the latest professional speed dome camera from VIVOTEK, specifically designed to enhance low light surveillance in large coverage areas. Equipped with 150 M IR illuminators and a 20x optical zoom lens, the SD9363-EHL-v2 provides a superb low light image in the most challenging situations. The SD9363-EHL-v2 also adopts VIVOTEK's Smart IR II technology, which provides smooth vari-angle adjustment of the IR illuminators, allowing broad coverage FOV and highly uniform IR intensity while avoiding hot-spots traditionally associated with IR illumination

The SD9363-EHL-v2 is the PTZ surveillance camera with IR illumination to utilize H.265 compression technology. When combined with VIVOTEK's Smart Stream II technology users can obtain bandwidth savings of up to 80%* compared to traditional H.264. By combining 1080p full HD resolution with H.265, IR

illuminators, Smart IR II, WDR, and 20x optical zoom, the SD9363-EHL-v2 is able to capture fine details at top-notch quality, 24 hours a day, 7 days a week.

VIVOTEK further strengthened the camera performance with an IP66- and NEMA 4X-rated housing to protect the camera against rain, dust, and corrosion. The SD9363-EHL-v2 has a wide operating temperature range from -50°C to 55°C, ensuring continuous operation under the most extreme weather conditions and hazardous environments. This makes the SD9363-EHL-v2 ideally suited to monitor wide open spaces such as ports, highways, cities, and parking lots where high-level precision is required.

* Depending on scene.

Key Features

- Real-time H.265, H.264 and MJPEG Compression (Triple Codec)
- 60 fps @ 1080p Full HD
- 20x Zoom Lens
- 150M IR with Smart IR II (Vari-Angle IR)
- WDR Pro for Unparalleled Visibility in High Contrast Environments
- Weather-proof IP66, Vandal-proof IK10 and NEMA 4X-rated Housing
- -50°C ~ 55°C Wide Temperature Range for Extreme Weather Conditions (AC 24V/ PoH)
- Smart Stream II to Optimize Bandwidth Efficiency
- EIS (Electronic Image Stabilization) to Control Image Stability
- Power Redundant Supported



Without Smart IR II



With Smart IR II

Technical Specifications

Model	SD9363-EHL-v2	Dynamic Range	110 dB
System Information		Video Streaming	Adjustable resolution, quality and bitrate; Smart Stream II
CPU	Multimedia SoC (System-on-Chip)	Image Settings	Adjustable image size, quality and bit rate; Time stamp, text overlay, flip & mirror; Configurable brightness, contrast, saturation, sharpness, white balance, exposure control, gain, backlight compensation, privacy masks (Up to 24); Scheduled profile settings, defog, 3DNR, EIS, HLC
Flash	128MB	Audio	
RAM	512MB	Audio Capability	Two-way Audio
Camera Features		Compression	G.711, G.726
Image Sensor	1/3" Progressive CMOS	Interface	External microphone input External line output
Max. Resolution	1920x1080	Network	
Lens Type	20x Optical Zoom, Auto Focus	Users	Live viewing for up to 10 clients
Focal Length	f = 4.7 ~ 94 mm (20x zoom)	Protocols	IPv4, IPv6, TCP/IP, HTTP, HTTPS, UPnP, RTSP/ RTP/RTCP, IGMP, SMTP, FTP, DHCP, NTP, DNS, DDNS, PPPoE, CoS, QoS, SNMP, 802.1X, UDP, ICMP, ARP, TLS, NTCIP
Aperture	F1.6 ~ F3.5	Interface	10 Base-T/100 Base-TX Ethernet (RJ-45) *It is highly recommended to use standard CAT5e & CAT6 cables which are compliant with the 3P/ETL standard.
Iris type	DC-iris	ONVIF	Supported, specification available at www.onvif.org
Field of View	3° ~ 55° (Horizontal) 2° ~ 33° (Vertical) 3° ~ 63° (Diagonal)	Intelligent Video	
Shutter Time	1/8 sec. to 1/30,000 sec.	Video Motion Detection	Five-window video motion detection
WDR Technology	WDR Pro	Auto-Tracking	Auto-tracking on moving object
Minimum Illumination	0.26 Lux @ F1.6 (Color) 0.01 Lux @ F1.6 (B/W) 0 Lux with IR illumination on	Alarm and Event	
Day/Night	Removable IR-cut filter for day & night function	Alarm Triggers	Motion detection, manual trigger, digital input, periodical trigger, system boot, recording notification, audio detection, MicroSD card life expectancy
Pan Speed	0.1° ~ 300° / sec.	Alarm Events	Event notification using digital output, HTTP, SMTP, FTP, NAS server and MicroSD card File upload via HTTP, SMTP, FTP, NAS server and MicroSD card
Pan Range	360° endless	General	
Tilt Speed	0.1° ~ 300° / sec.	Connectors	RJ-45 cable connector for Network 10/100 Mbps PoE connection*1 Audio input*1 Audio output*1 AC/DC 24V power input*1 Digital input*4 Digital output*2 RS-485 for PTZ control (PelcoD protocol, Baud rate 2400)*1
Tilt Range	220° (-110° ~ +110°)	LED Indicator	System power and status indicator
Preset Locations	256 preset locations 128 presets per tour	Power Input	PoH/PoE (95W) AC/DC 24V
Pan/Tilt/Zoom Functionalities	128x digital zoom (4x on IE plug-in, 32x built-in), Auto pan mode, Auto patrol mode		
IR Illuminators	Built-in IR Illuminators up to 150 meters with Smart IR II, IR LED*2		
On-board Storage	Slot type: MicroSD/SDHC/SDXC card slot Seamless Recording		
Video			
Compression	H265, H264, MJPEG		
Maximum Frame Rate	H.265 & H.264: 60 fps @ 1920x1080 MJPEG: 30 fps @ 1920x1080		
Maximum Streams	4 simultaneous streams		
S/N Ratio	53 dB		

Technical Specifications

Power Consumption	PoH/PoE (95W): Max. 70 W (Heater on) Max. 51 W (Heater off) AC/DC 24V: Max. 63 W (Heater on) Max. 45 W (Heater off)
Dimensions	237 x 364 mm
Weight	7.1 kg (with bracket) 5.7 kg (without bracket)
Casing	IP66, IK10, NEMA 4X
Safety Certifications	CE, FCC Class A, VCCI, C-Tick, NEMA 4X, UL
Operating Temperature	Starting Temperature: -40°C ~ 55°C (-40°F ~ 131°F) Working Temperature: -40°C ~ 55°C (-40°F ~ 131°F), DC 24V power input -50°C ~ 55°C (-58°F ~ 131°F), AC 24V/ PoH(95W) power input
Humidity	98%
Warranty	36 months
System Requirements	
Operating System	Microsoft Windows 8/7 Mac 10.12 (Chrome only)
Web Browser	Chrome 58.0 or above Internet Explorer 10/11

Other Players

VLC: 1.1.11 or above
Quicktime: 7 or above

Included Accessories







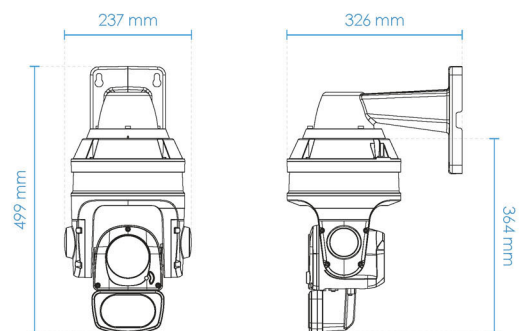







Others

Wall mount bracket, I/O cable, screws, waterproof connectors, terminal blocks, quick installation guide, warranty card, alignment sticker, ground wire, T25 star driver, desiccant bags

Dimensions



Compatible Accessories

Mounting Kits		Others		
 AM-220 Wall Mount Bracket	 AM-529 Mounting Adapter	 AJ-001 USB Joystick	 AJ-002 USB Joystick	 AO-007 I/O Combo Cable
Cabinet				
 AT-CAS-001 Cabinet for Speed Dome	 AT-CAB-002 Cabinet for HLG Power Supply	 AT-SUN-002 Sunshield	 AT-SWH-000 Power Safety Kit	
PoE Kit/Power Adapter				
24VAC			24VDC	
 AA-341 AC 24V 3.5A Power Adapter	 AA-351 Outdoor Power Box, 24VAC/144W, IP67, IK10	 AA-352 Outdoor Power Box, 24VAC/144W, IP67, IK10	 HLG-120H-24 Industrial 24VDC/120W Power Supply, IP67	

Compatible Accessories

95W PoH/PoE

 AW-IHH-0100 Industrial 1xGE 95W PoH/PoE Injector	+	 HLG-120H-54 Industrial 54VDC/120W Power Supply, IP67	 AW-IHH-0200 Industrial 1xGE 95W PoH/PoE + 1x SFP GE Switch	+	 HLG-120H-54 Industrial 54VDC/120W Power Supply, IP67	 AP-GIC-011A-095 1xGE 95W PoH/PoE Injector with Surge Protection 12KV	 AP-GIC-015B-095 Outdoor 1xGE 95W PoH/PoE Injector with Surge Protection 12KV, IP67, IK10
---	---	---	---	---	---	---	---

Distributed by:



CHECOL TECHNOLOGY LIMITED

Tel / Fax : +(852) 2560 7011 / +(852) 2535 6388

Email : mail@checol.com

Address : G/F, 57 King Yip Street, Kwun Tong, Kowloon, HK



All specifications are subject to change without notice. Copyright © VIVOTEK INC. All rights reserved. Ver. 4